

MESTIZAJE

WOW

Introduction / Introducción



MESTIZAJE

Mix of cultures

Mestizaje is our appreciation to the imperfect and the natural. Embracing ancestral "Zellige" art and the antique terracotta charms.

Zellige walls are a tribute to the North African Zellige craftsmanship, treasured from one generation to another.

We propose vibrant translucent colours with 12 blended shades for each one, surface textures and shaped backs for your walls; in combination with **Chateau** floors, inspired in graceful French terracotta, century old beauty of clay in chalky colours, embellished by the passage of time.

Mestizaje breaths new life into each ceramic piece.

Mestizaje es nuestra apreciación de lo imperfecto y lo natural. Abarcando el arte ancestral del Zellige y el encanto de la antigua terracota.

Zellige es un homenaje a la artesanía Zellige del norte de África, atesorada generación tras generación.

Proponemos colores translúcidos vibrantes, con 12 tonos mezclados para cada uno, superficies texturadas y reverso de las piezas de aspecto cincelado; en combinación con los pavimentos Chateau, inspirados en la elegante y grácil terracota francesa, la belleza centenaria de la tierra y sus colores arcillosos embellecidos por el paso del tiempo.

Mestizaje aporta viveza y autenticidad a cada una de sus piezas.

MESTIZAJE

Product introduction / Introducción de productos

Zellige

5"x5" / 12,5x12,5 cm

(Different colour shades randomly mixed within the box / Diferentes tonalidades encajadas aleatoriamente)



White Matt

White

Grey

Graphite

Aqua

Turques

Zellige Decor

5"x5" / 12,5x12,5 cm

(24 Different patterns randomly mixed within the box / 24 diseños encajados aleatoriamente)

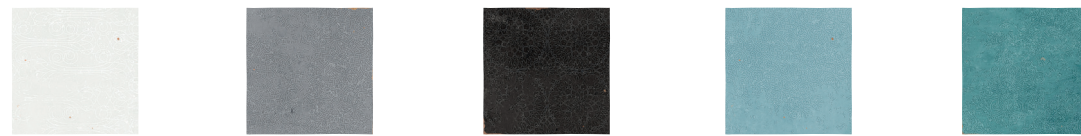

White

Grey

Graphite

Aqua

Turques

Zellige Bullnose

1.5"x5" / 3,5x12,5 cm



White Matt

White

Grey

Graphite

Aqua

Turques

Chateau Crayon

1.5"x9" / 4x22,6 cm

(Different colour shades randomly mixed within the box / Diferentes tonos encajados aleatoriamente)



White Gloss

Cotto

Graphite

Chateau

7"x7" / 18,5x18,5 cm

(Different colour shades randomly mixed within the box / Diferentes tonos encajados aleatoriamente)



White Gloss

Cotto

Graphite

Chateau Lines

7"x7" / 18,5x18,5 cm



White Gloss

Cotto

Graphite

Chateau Antique

7"x7" / 18,5x18,5 cm

(28 Different patterns randomly mixed within the box / 28 diseños encajados aleatoriamente)



White Gloss

Cotto

Graphite

ZELLIGE
5"x5" / 12,5x12,5 cm

08



ZELLIGE DECOR
5"x5" / 12,5x12,5 cm

20



CHATEAU
7"x7" / 18,5x18,5 cm

30



CHATEAU LINE
7"x7" / 18,5x18,5 cm

34



CHATEAU ANTIQUE
7"x7" / 18,5x18,5 cm

38



CHATEAU CRAYON
1.5"x9" / 4x22,6 cm

44



TECHNICAL FEATURES
Características técnicas

50

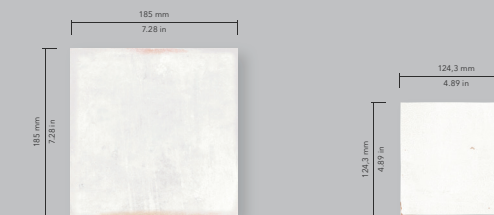

ZELLIGE

5"x5" / 12,5x12,5 cm



White Matt



White



Grey



Graphite

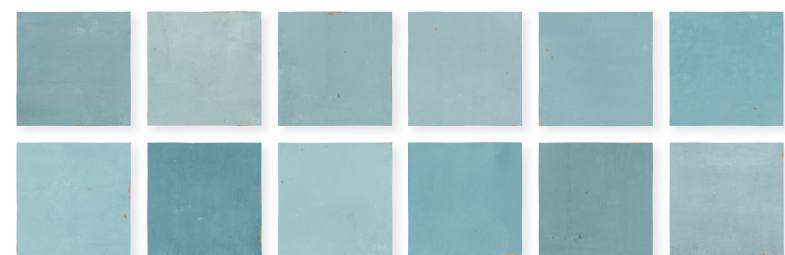

Aqua



Turques

Different colour shades randomly mixed within the box / Diferentes tonalidades encajadas aleatoriamente.



Zellige
Graphite



Zellige
Turques



Zellige
Aqua
Chateau
White Gloss



Zellige
Graphite
Chateau
White Gloss



Zellige
Grey



Zellige
White
Chateau
Graphite



Zellige
White Matt



Zellige
White Matt

ZELLIGE BULLNOSE

1.5"x5" / 3,5x12,5 cm



Available colours / Colores Disponibles



White Matt



White

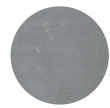

Grey



Graphite



Aqua



Turques

Different colour shades randomly mixed within the box / Diferentes tonalidades encajadas aleatoriamente.



Zellige Bullnose

Grey
Zellige
Grey

ZELLIGE DECOR

5" x 5" / 12,5 x 12,5 cm

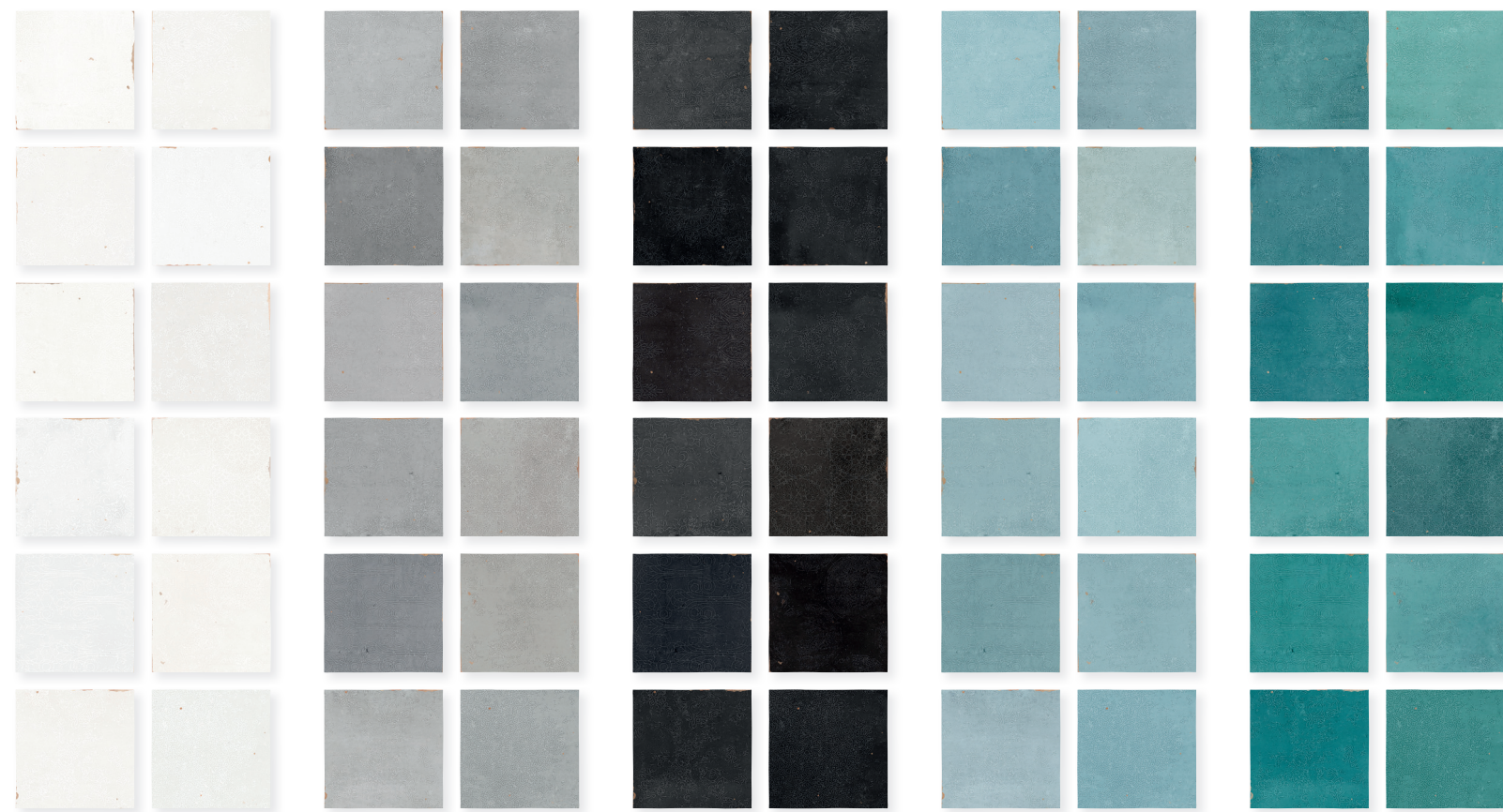

White

Grey

Graphite

Aqua

Turques

24 different patterns randomly mixed within the box / 24 diseños diferentes encajados aleatoriamente.



Zellige Decor
Turques



Zellige & Zellige Decor
Graphite



Zellige & Zellige Decor
Graphite



Zellige & Zellige Decor
Grey



Zellige & Zellige Decor
White



Zellige & Zellige Decor
Aqua



Zellige Decor
Turques

CHATEAU

7"x7" / 18,5x18,5 cm



White Gloss

Cotto

Graphite

Different colour shades randomly mixed within the box / Diferentes tonalidades encajadas aleatoriamente.



Chateau
Cotto

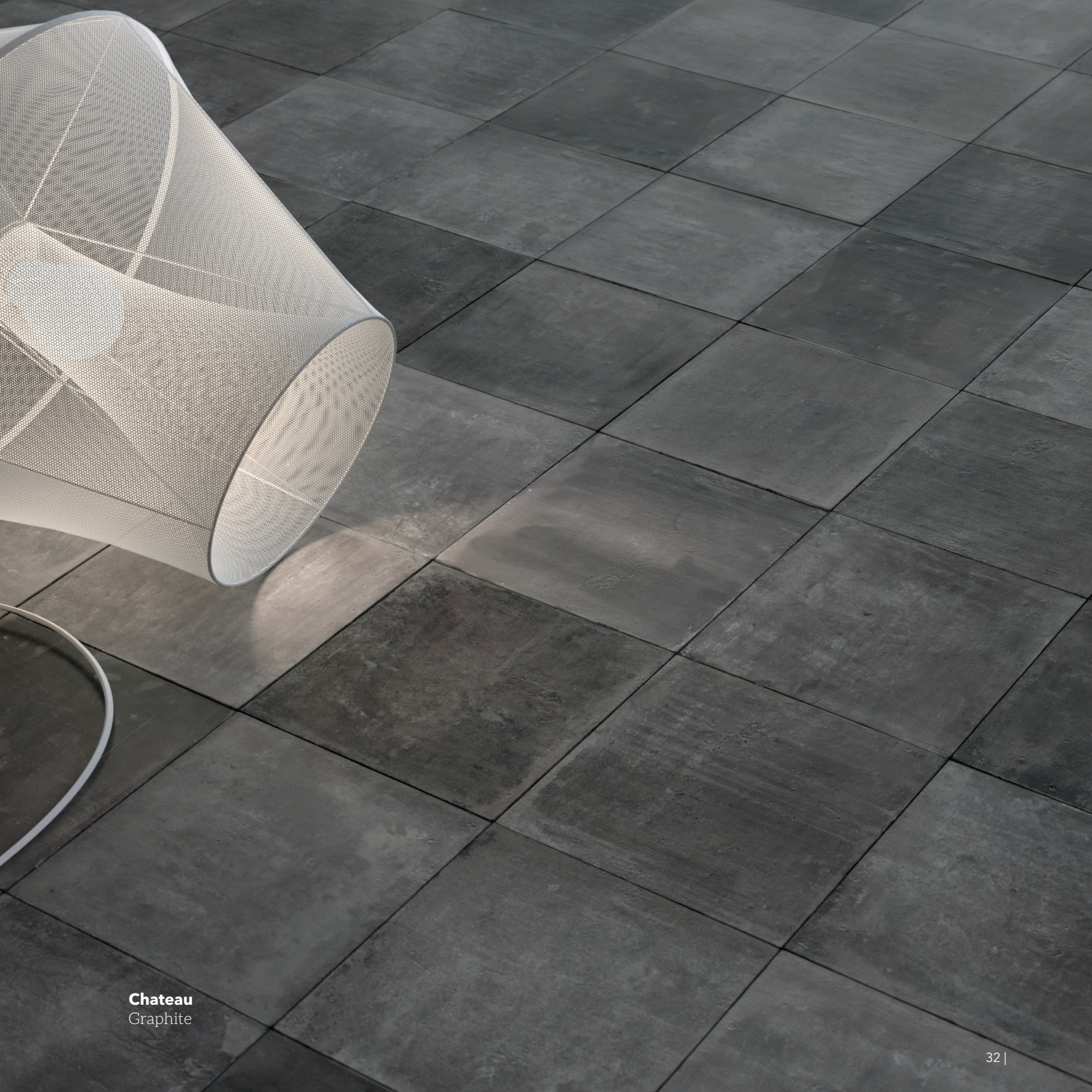

Chateau
Graphite



Chateau
White Gloss

CHATEAU LINES

7"x7" / 18,5x18,5 cm

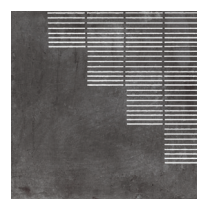
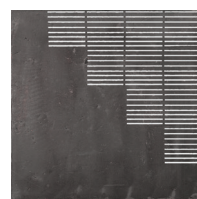
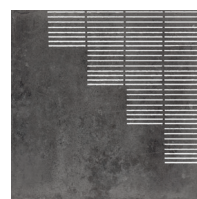
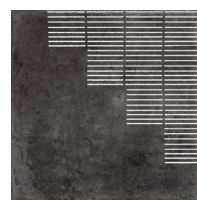
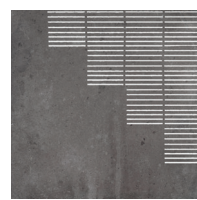

White Gloss

Cotto

Graphite

Different colour shades randomly mixed within the box / Diferentes tonalidades encajadas aleatoriamente.



Chateau Lines
Graphite



Chateau Lines
Cotto



Chateau Lines
White Gloss

CHATEAU ANTIQUE

7"x7" / 18,5x18,5 cm

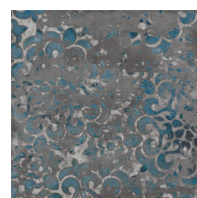
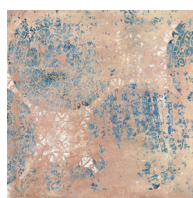
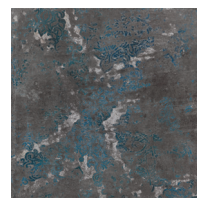
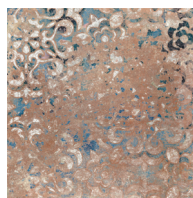
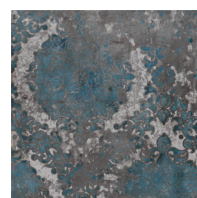

White Gloss

Cotto

Graphite

28 different patterns randomly mixed within the box / 28 diseños diferentes encajados aleatoriamente.



Chateau Antique
White Gloss





Chateau Antique
Graphite

Zellige
White



Chateau Antique
Graphite

CHATEAU CRAYON

1.5"x9" / 4x22,6 cm



White Gloss



Cotto



Graphite

Different colour shades randomly mixed within the box.
Diferentes tonalidades encajadas aleatoriamente.



Chateau 66,6%
Chateau Crayon 33,4%
Cotto

Chateau 66,6%
Chateau Crayon 33,4%
Graphite



Chateau Crayon 33,4%
White Gloss
Chateau 66,6%
Cotto



Chateau 66,6%
Chateau Crayon 33,4%
White Gloss

MESTIZAJE











Technical Features / Información Técnica



CHATEAU

Dry-pressed ceramic tiles with water absorption B la ≤ 0,5% for interior and exterior floors and walls.







Baldosas cerámicas prensadas en seco con absorción de agua B la ≤ 0,5% para suelos y paredes interiores y exteriores.

FEATURES / CARACTERÍSTICAS	SPECIFICATION / ESPECIFICACIÓN	NORMA
 Dimensional Features	186 mm +/- 0,6 % x 186 mm +/- 0,6 % 40 mm +/- 0,6 % x 226 mm +/- 0,6 %	UNE-EN ISO 10545-2:1998
 Water absorption	$E_b \leq 0,5\%$	UNE-EN ISO 10545-3:1997
 Modulus of rupture and breaking strength	Minimum 35 N/mm ² Individual Minimum 32 N/mm ²	UNE-EN ISO 10545-4:2012
 Abrasive resistance	2 - 4 According to model	UNE-EN ISO 10545-7:1999
 Crazing resistance	Pass	UNE-EN ISO 10545-11:1997
 Frost resistance	Pass	UNE-EN ISO 10545-11:1997
 Household products resistance	GA	UNE-EN ISO 10545-13:1998
 Chemical resistance	Cotto & Graphite: GHA White Gloss: GLB	UNE-EN ISO 10545-13:1998
 Stain resistance	>3	UNE-EN ISO 10545-14:1998
 Non-slip value	R10 / CLASS 1 DCOF >0,46 (Except Chateau White Gloss)	DIN 51130:2014 ANSI A137.1:2012

ZELLIGE

Technical features for Dry-Pressed ceramic tiles with water absorption BIII (Eb >10%)

Características técnicas para las baldosas cerámicas prensadas en seco del grupo BIII (Eb >10%)

FEATURES / CARACTERÍSTICAS	SPECIFICATION / ESPECIFICACIÓN	NORMA
 Dimensional Features	125,7 mm +/- 0,75 mm x 125,7 mm +/- 0,75 mm	UNE-EN ISO 10545-2:1998
 Water absorption	$E_b > 10\%$	UNE-EN ISO 10545-3:1997
 Modulus of rupture and breaking strength	Thickness ≥ 7,5 mm mínimo 12 N/mm ² Thickness < 7,5 mm mínimo 15 N/mm ²	UNE-EN ISO 10545-4:2012
 Crazing resistance	Pass	UNE-EN ISO 10545-11:1997
 Household products resistance	GA	UNE-EN ISO 10545-13:1998
 Chemical resistance	GHA	UNE-EN ISO 10545-13:1998
 Stain resistance	Class 5	UNE-EN ISO 10545-14:1998

MESTIZAJE

Recommendations / Recomendaciones

Technical Drawings / Planimetría



WAREHOUSING

In order to guarantee the characteristics of the finish the product must be kept in its original packaging until the time of fixing. If the product is likely to be stored for a long period of time it should be suitably covered.

TILE FIXING

To ensure the products adhere correctly to the surface, it is essential to use specific adhesive and grouting material. This must also be suitable for the environment they will have to withstand. Fitting with traditional mortars does not ensure good adhesion.

Due to the nature of the material there may be dimensional variations between pieces. Therefore, all types of joints must be planned and carried out correctly: structural, perimeter, expansion and installation joints. Fitting tiles without joints is not advisable from any technical point of view as this may lead to various problems. For an optimal result, we advise to use 2 mm (0.08") grout for Chateau and 1 mm (0.04") for Zellige.

MAINTENANCE AND CLEANING

Once the materials have been fitted, it is advisable to remove any remaining adhesive and grouting material by using a commercial descaling product designed especially, diluted with water. The descaling product must not remain in contact with the surface to be cleaned for more than 5 minutes.

As a general guideline, powder detergents should not be used, not wire wool or abrasive materials. Generally a sponge will be sufficient with warm water and liquid neutral soap. Then rinse with plenty of clean water.

ALMACENAMIENTO

Para garantizar las características de su acabado, el producto debe mantenerse en su embalaje original hasta el momento de la colocación. Si el producto va a permanecer almacenado durante un largo periodo es conveniente hacerlo bajo cubierta.

COLOCACIÓN

Para garantizar una buena adhesión al soporte es necesaria la utilización de materiales de agarre y de rejuntado adecuados al ambiente al que vayan a estar sometidos. La colocación con morteros tradicionales no garantiza una buena adhesión.

Debido a la naturaleza del material pueden existir diferencias dimensionales entre piezas. Por ello deberán planificarse y ejecutarse correctamente todo tipo de juntas: estructurales, perimetrales, de dilatación y de colocación. La colocación sin juntas es desaconsejable desde cualquier punto de vista técnico, pudiendo ser el origen de diversas patologías. Para un resultado óptimo, recomendamos usar 2 mm de junta para Chateau y 1 mm para Zellige.

MANTENIMIENTO Y LIMPIEZA

Finalizada la puesta en obra se recomienda eliminar los restos de materiales de agarre y rejuntado con un desincrustante comercial diseñado expresamente para baldosas cerámicas, rebajado con agua, permaneciendo en contacto con la superficie a limpiar no más de 5 minutos.

Como norma general no deben utilizarse detergentes en polvo ni estropajos metálicos o abrasivos. Generalmente será suficiente con una esponja, agua tibia y un jabón líquido neutro. Posteriormente aclarar con abundante agua limpia.

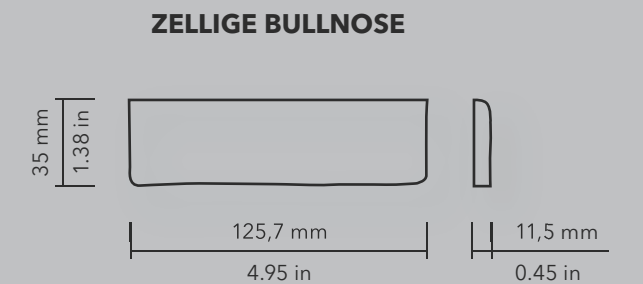
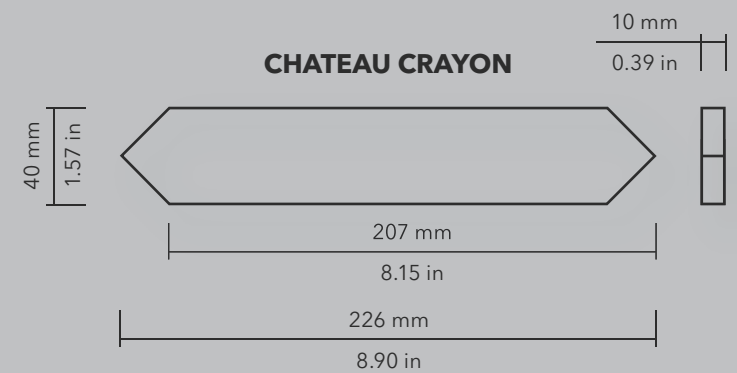
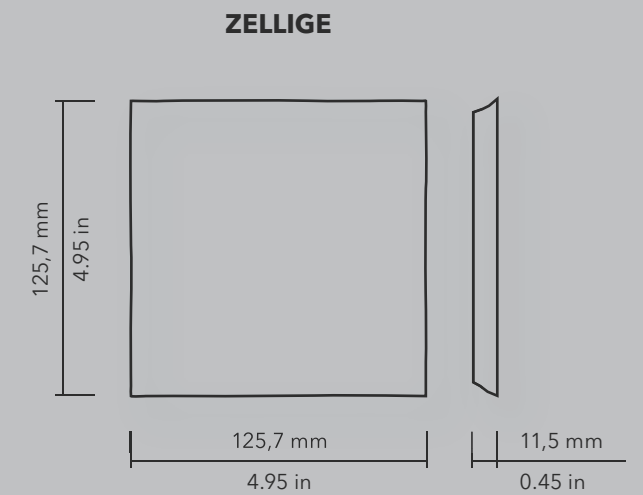
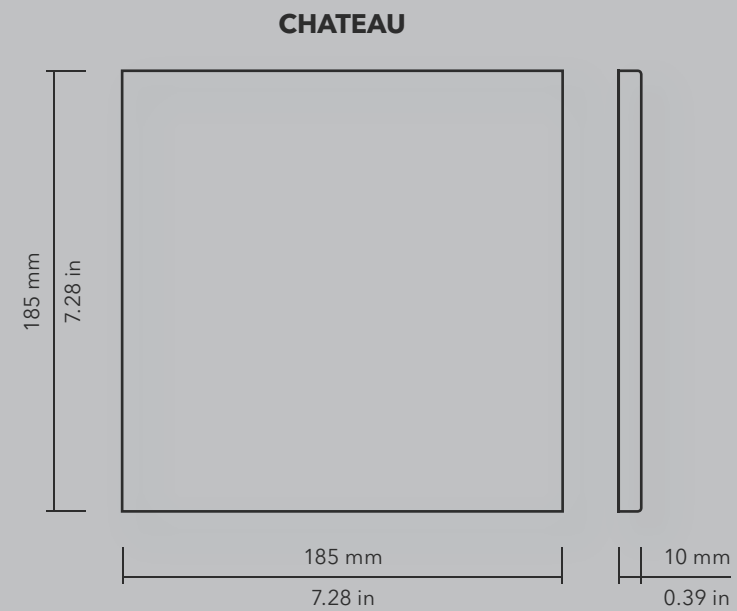

**MESTIZAJE
Packing**

Chateau + Chateau Crayon



Model	Size (in)	Pieces/box	lb/box	sq ft/box	Box/pallet	sq ft/pallet
Zellige	5"x5"	27	17.39 lb	4.52 sq ft	102	461.04 sq ft
Zellige Decor	5"x5"	27	17.39 lb	4.52 sq ft	102	461.04 sq ft
Zellige Bullnose	1.5"x5"	36	6.94 lb	14.70 Lft	350	5,166 Lft
Chateau	7"x7"	12	19.66 lb	4.45 sq ft	108	480.60 sq ft
Chateau Lines	7"x7"	12	19.66 lb	4.45 sq ft	108	480.60 sq ft
Chateau Antique	7"x7"	12	19.66 lb	4.45 sq ft	108	480.60 sq ft
Chateau Crayon	1.5"x9"	46	18.03 lb	4.12 sq ft	90	371.07 sq ft

Modelo Model	Tamaño (cm) Size (cm)	Piezas/caja Pieces/box	Kg/caja kg/box	m ² /caja m ² /box	Cajas/palet Box/pallet	m ² /palet m ² /pallet
Zellige	12,5x12,5 cm	27	7,89 kg	0,42 m ²	102	42,84 m ²
Zellige Decor	12,5x12,5 cm	27	7,89 kg	0,42 m ²	102	42,84 m ²
Zellige Bullnose	3,5x12,5 cm	36	3,15 kg	4,48 m	350	1,568 m
Chateau	18,5x18,5 cm	12	8,92 kg	0,41 m ²	108	44,28 m ²
Chateau Lines	18,5x18,5 cm	12	8,92 kg	0,41 m ²	108	44,28 m ²
Chateau Antique	18,5x18,5 cm	12	8,92 kg	0,41 m ²	108	44,28 m ²
Chateau Crayon	4x22,6 cm	46	8,18 kg	0,38 m ²	90	34,47 m ²



To replicate this layout you need: 66.6% Chateau square tiles and 33.4% Crayon shaped tiles of the total surface.
For 1 sqm. : 0.666 sqm (7.168 sqft) square tiles and 0.334 sqm (3.595 sqft) Crayon shaped tiles.

Para reproducir esta composición, se necesita un 66,6% de la superficie total de pavimento Chateau cuadrado y un 33,4% de Crayon. Para 1 m² : 0,666 m² pavimento Chateau cuadrado y 0,334 m² Crayon.

Designed by



Polígono Pont, Avda. de España 114
12180 Cabanes,
Castellón (Spain)
t. +34 964 331 910 / f. +34 964 331 911

wowdesigneu.com
comercial@wowdesigneu.com

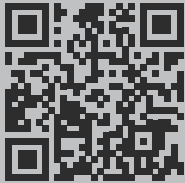

©2019 Tendencias Cerámicas

WOW, registered trademark of Tendencias Cerámicas, S.L.U

The brand use or reproduction of the contents of this catalog, is protected by copyright law. Any use of the brand or reproduction thereof, in part or total, must be authorized by Tendencias Cerámicas, S.L.U Otherwise, this action can be sanctioned according to the Law.

©2019 Tendencias Cerámicas

WOW, marca registrada por Tendencias Cerámicas, S.L.U

La utilización de la marca o la reproducción del contenido de este catálogo está protegida por la Ley de Propiedad Intelectual. Cualquier uso de la marca o la reproducción del mismo, en parte o en su totalidad, debe ser autorizada por Tendencias Cerámicas, S.L.U, pudiendo, en caso contrario, ser esta acción sancionada de acuerdo con la Ley.

WOW reserves the right to modify and/or discontinue certain models displayed in this catalogue.

The colour of the pieces displayed herein may differ slightly from originals.

The settings shown in this catalogue are design proposals for advertising purposes.

In real situations in which the pieces are laid, the installation instructions published by WOW should be followed.

WOW se reserva el derecho de modificar y/o suprimir ciertos modelos expuestos en este catálogo sin previo aviso.

Los colores de las piezas pueden presentar ligeras diferencias respecto a las originales.

Los ambientes que se muestran en este catálogo son sugerencias decorativas de carácter publicitario, debiéndose utilizar en la instalación real las instrucciones de colocación editadas por WOW.